

a A

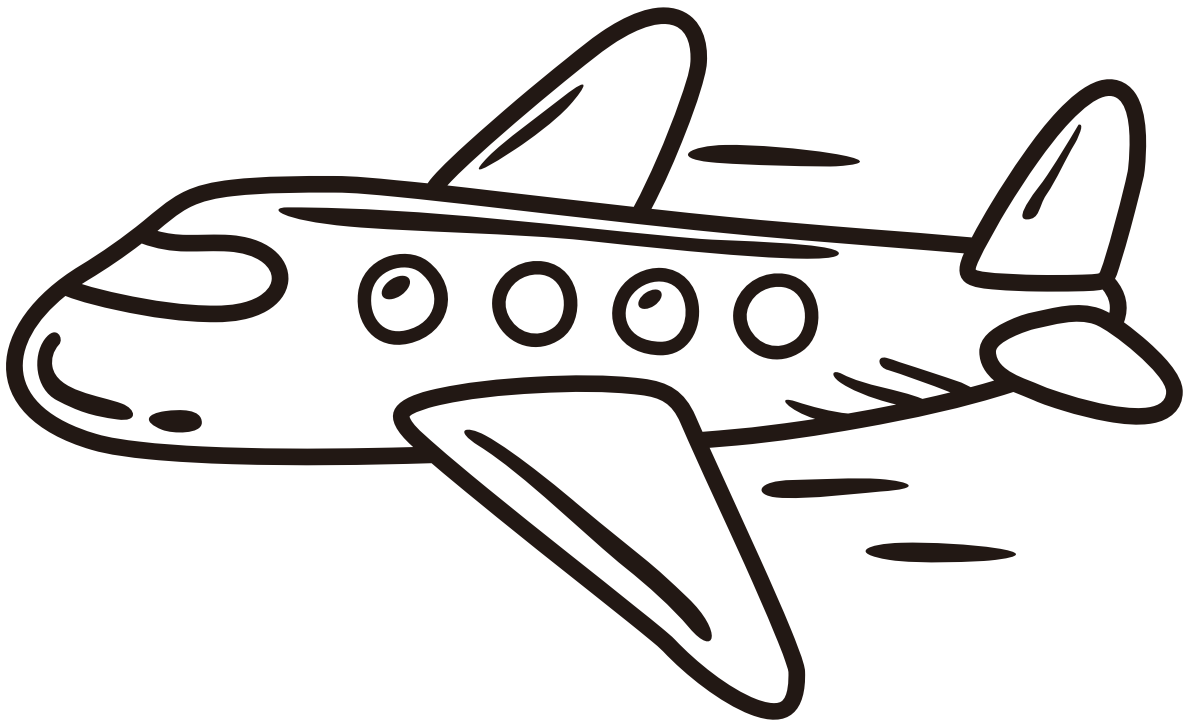

m M

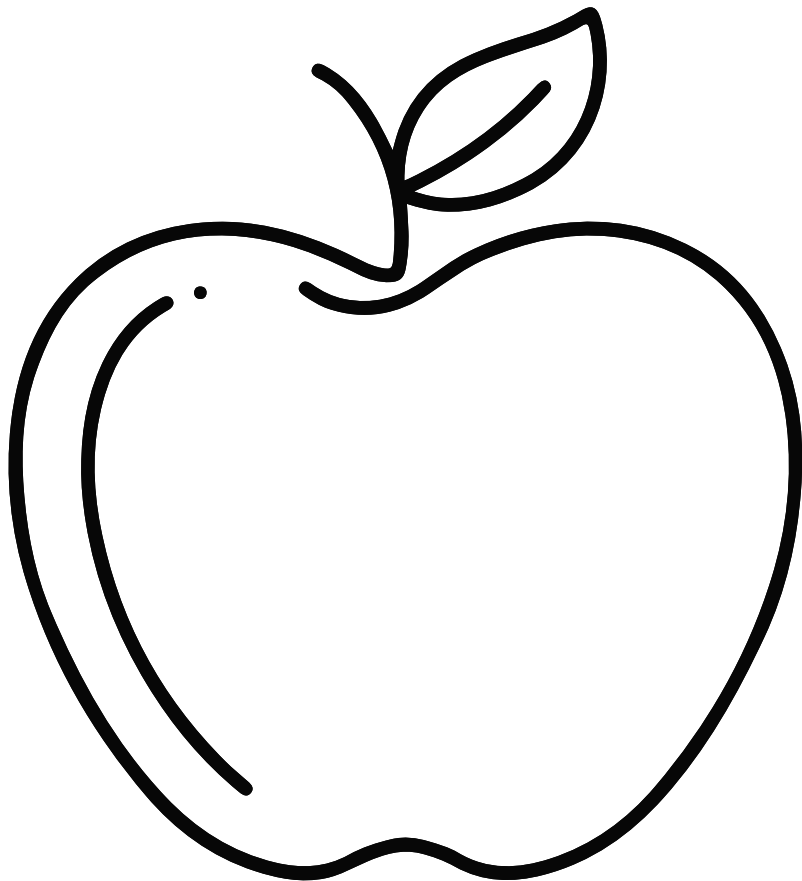

u uu

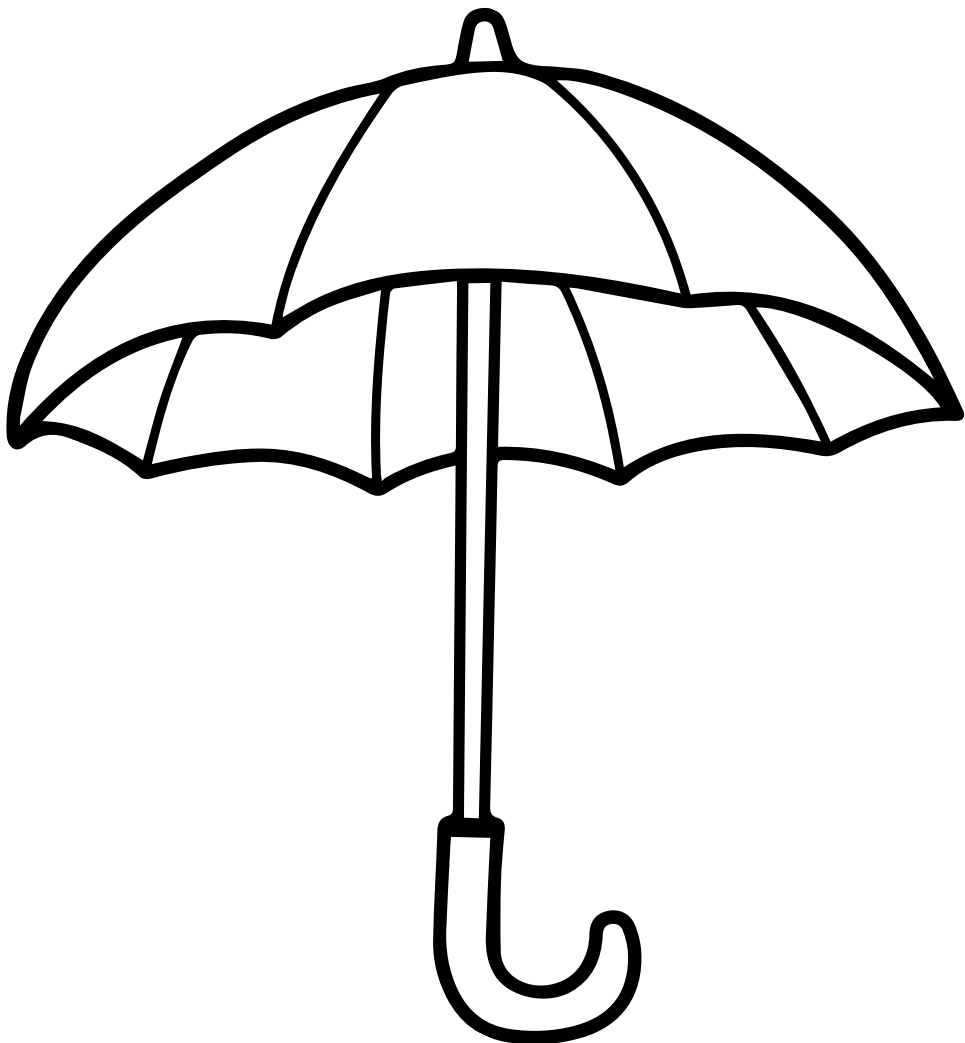

n n

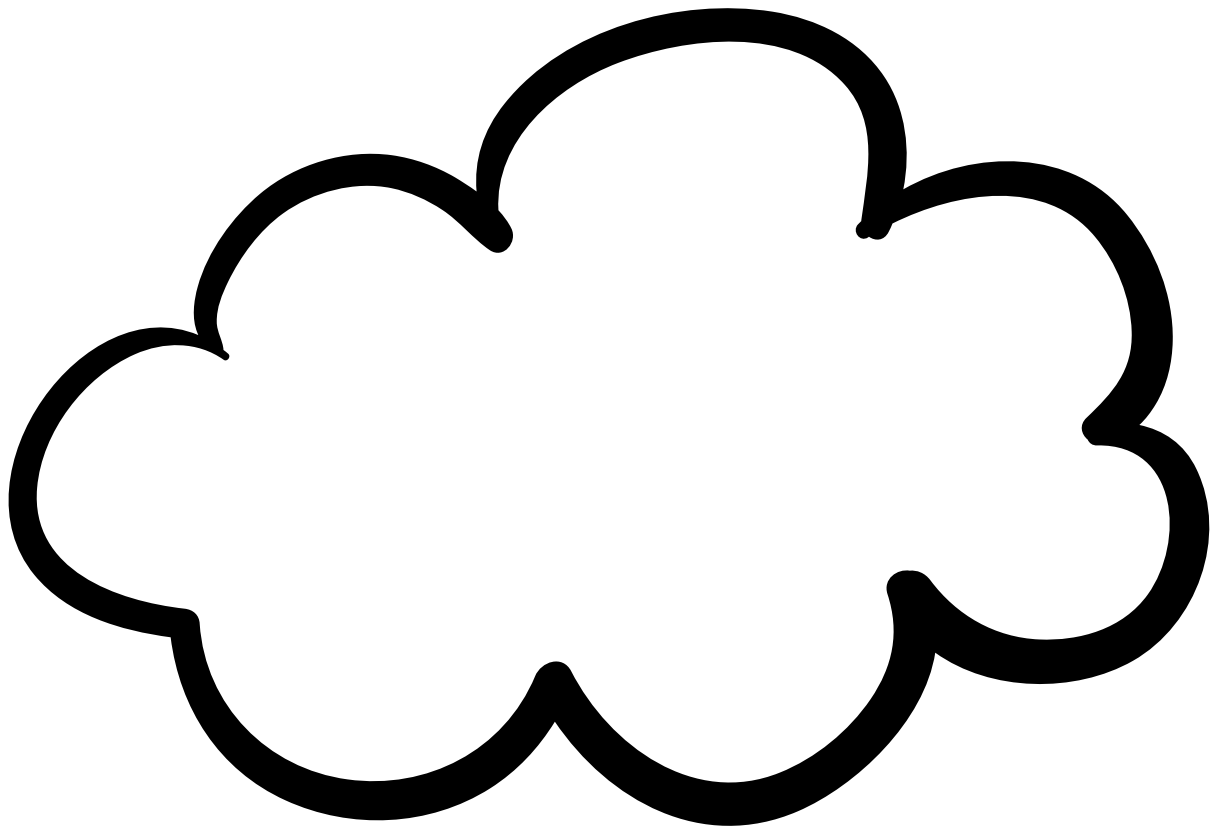

i I

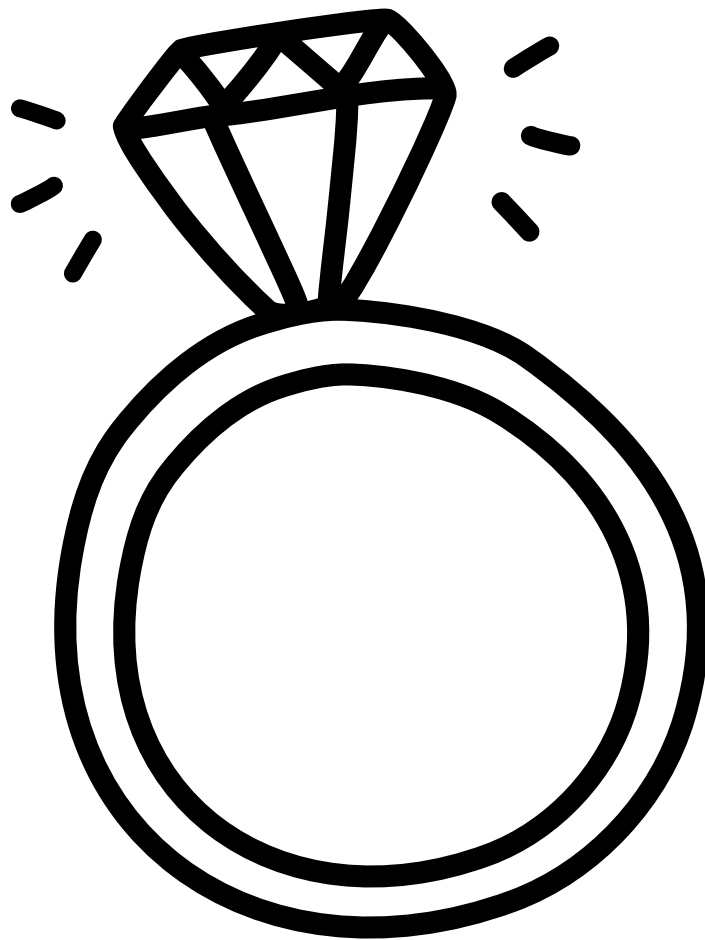

e E

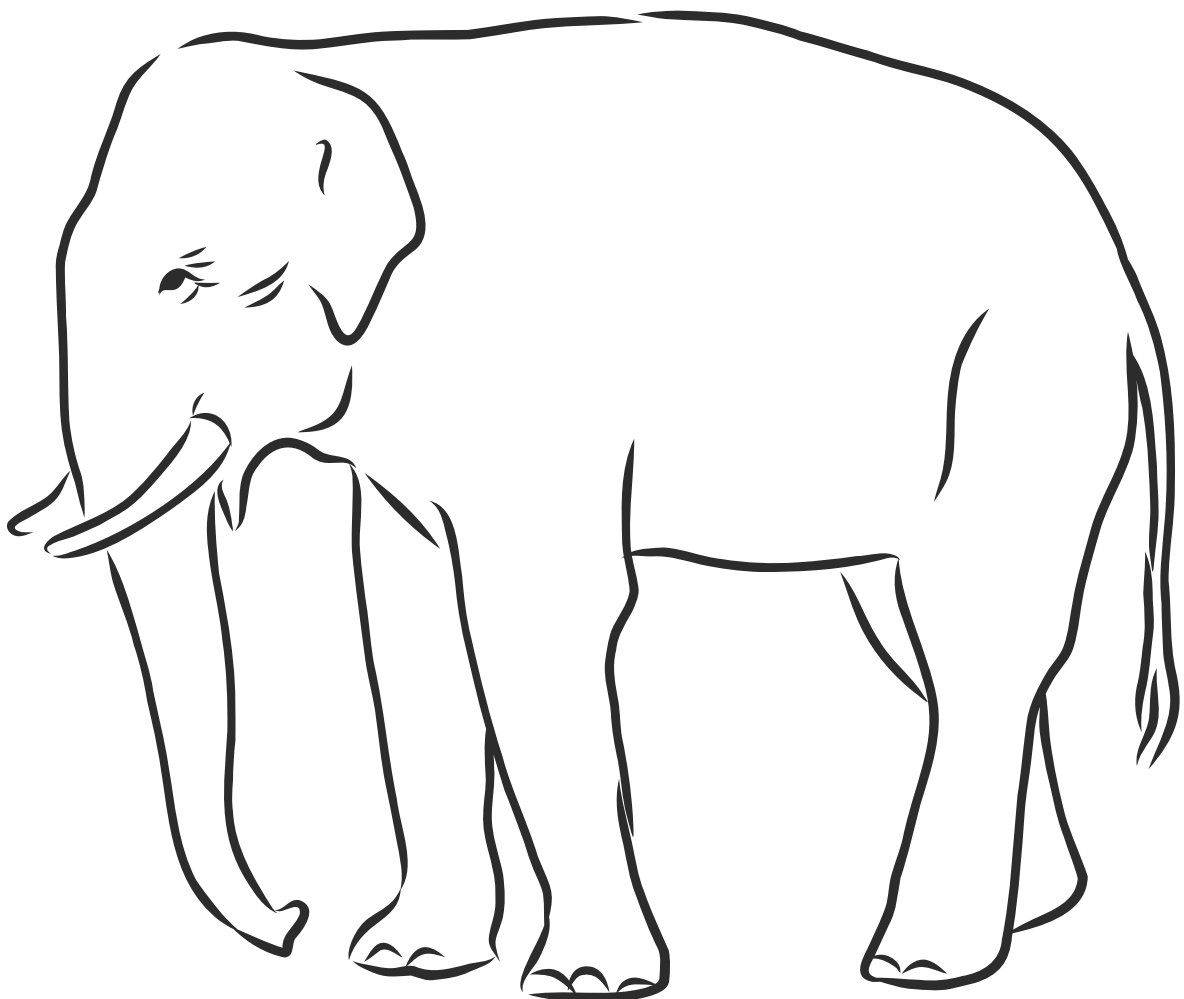

rR

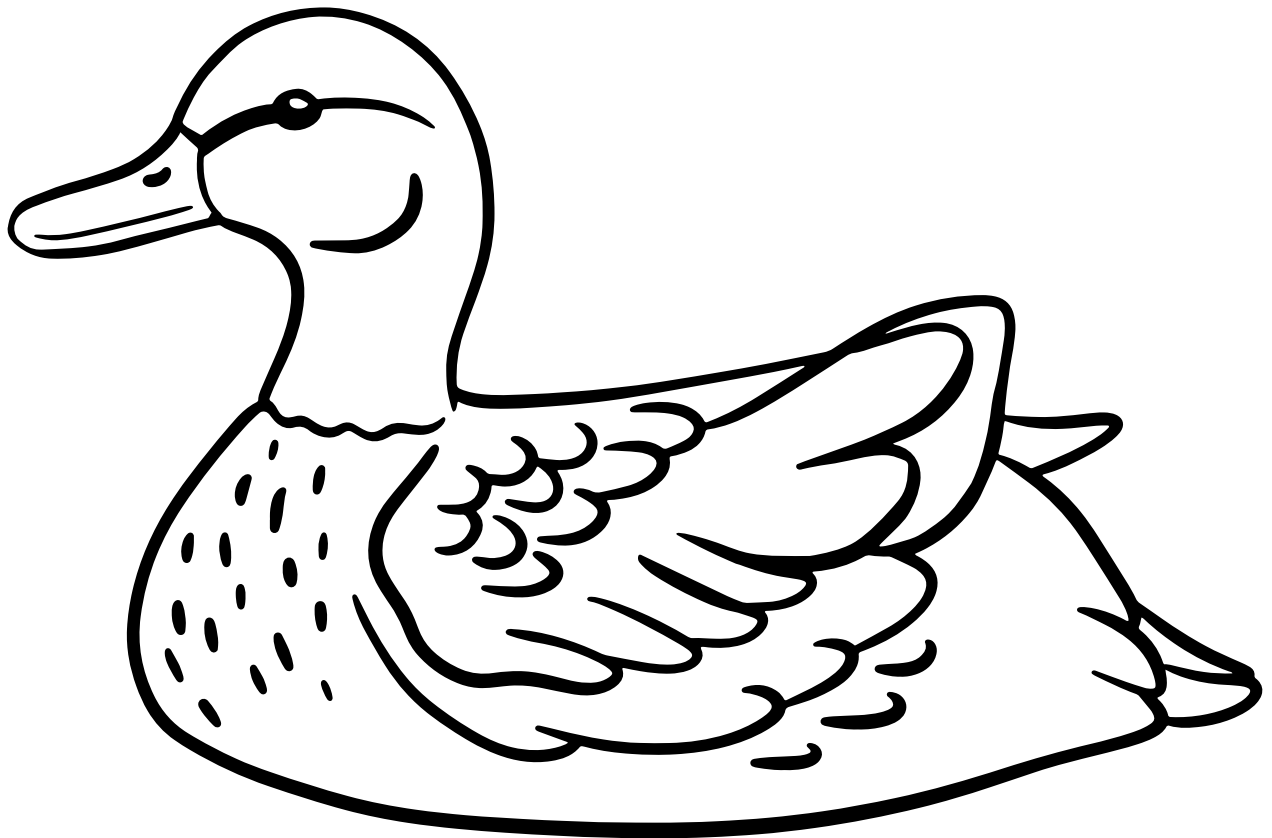

o O

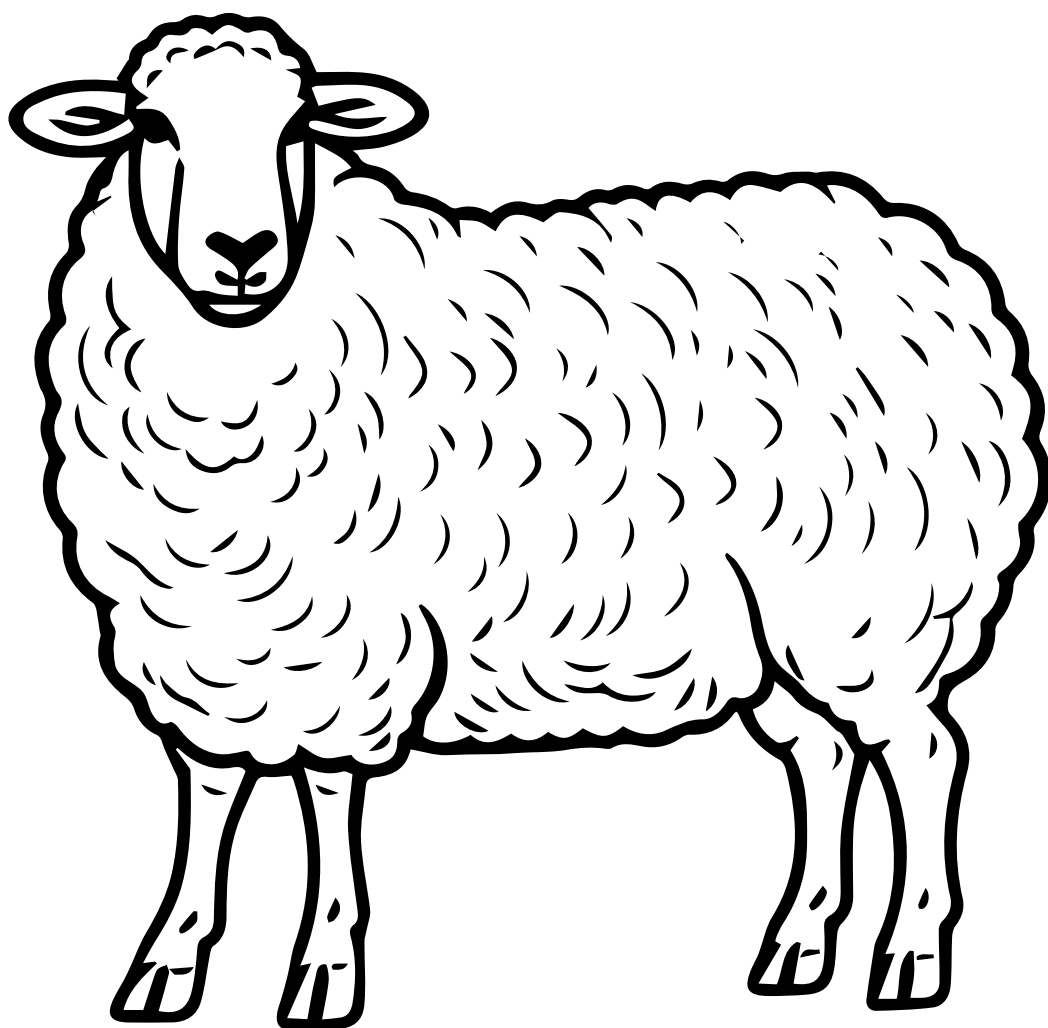



c C

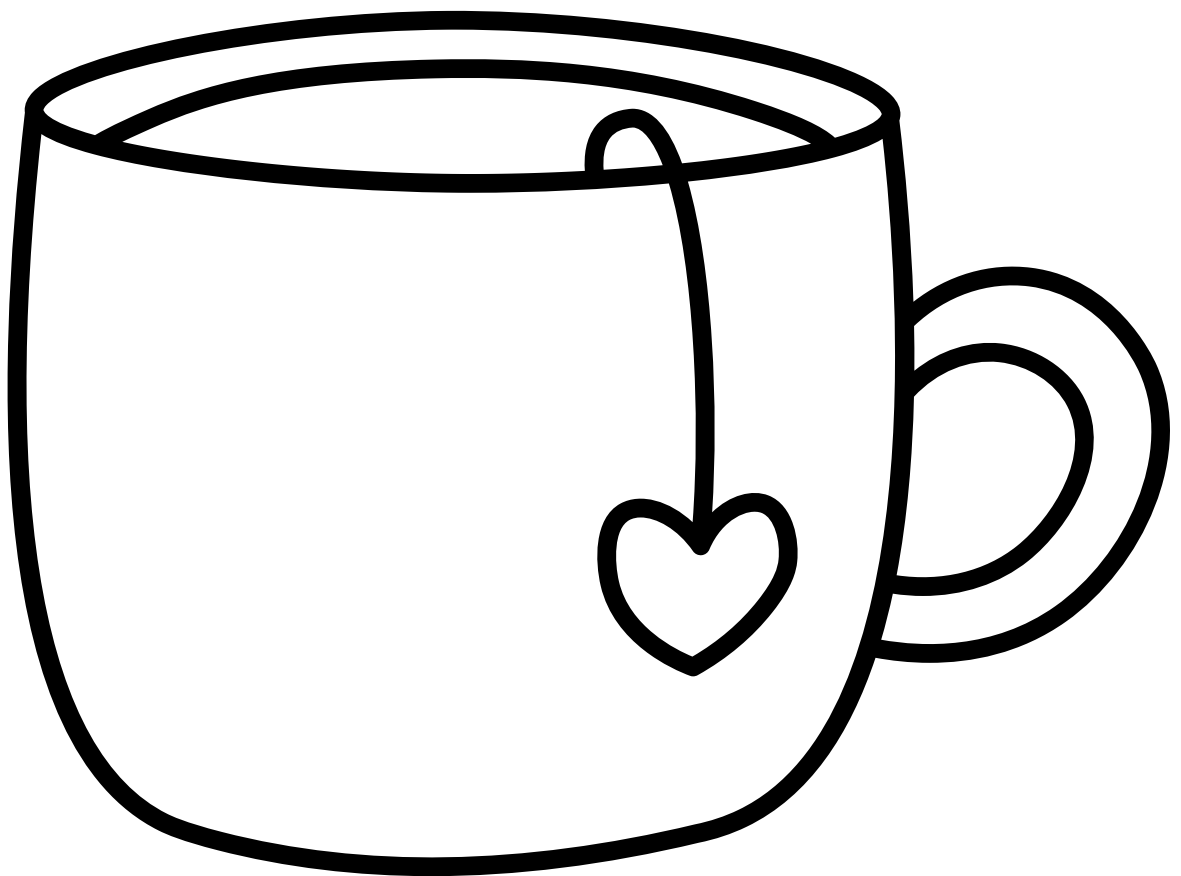

ă

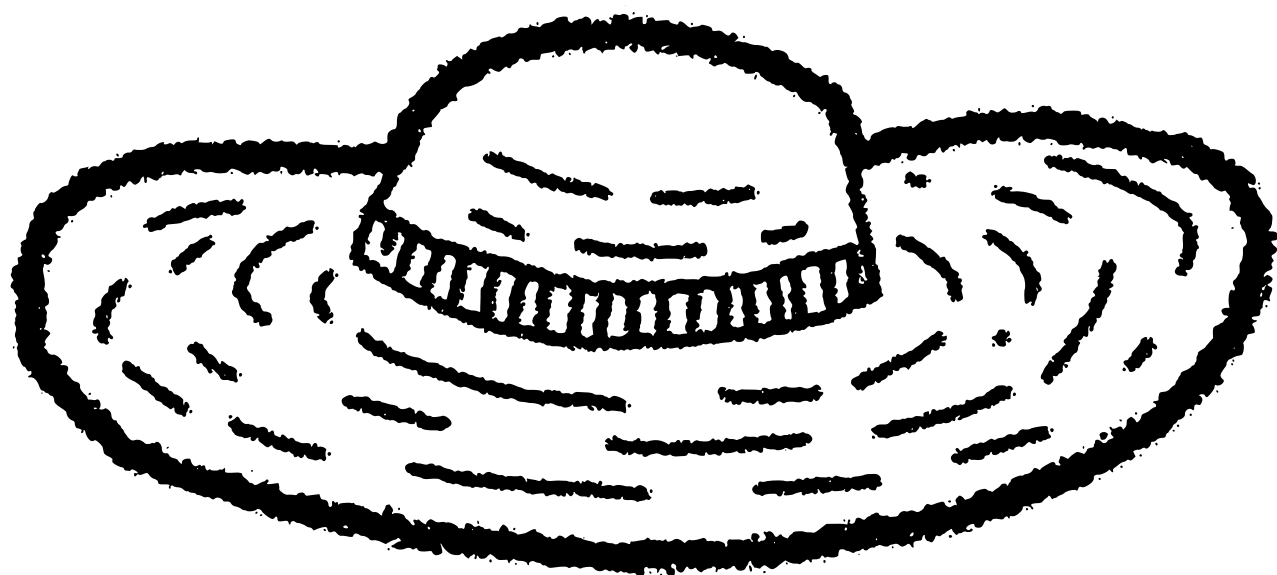

pălărie

IL

IL

t T



s S

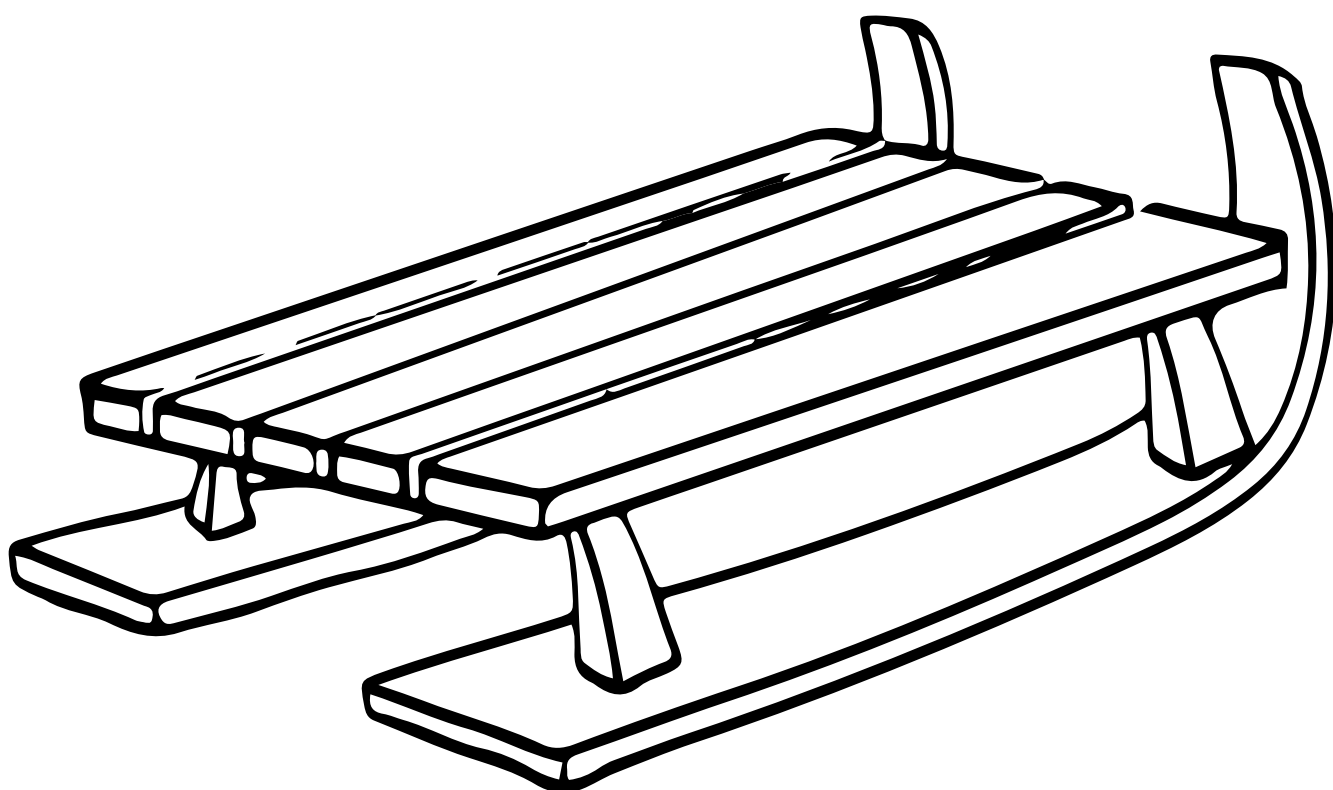

p P

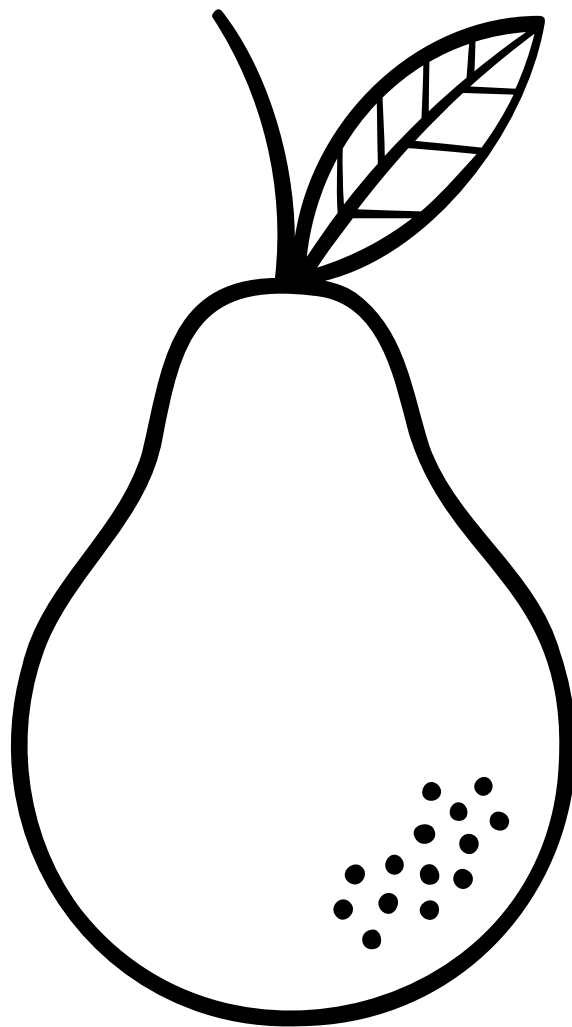

v w

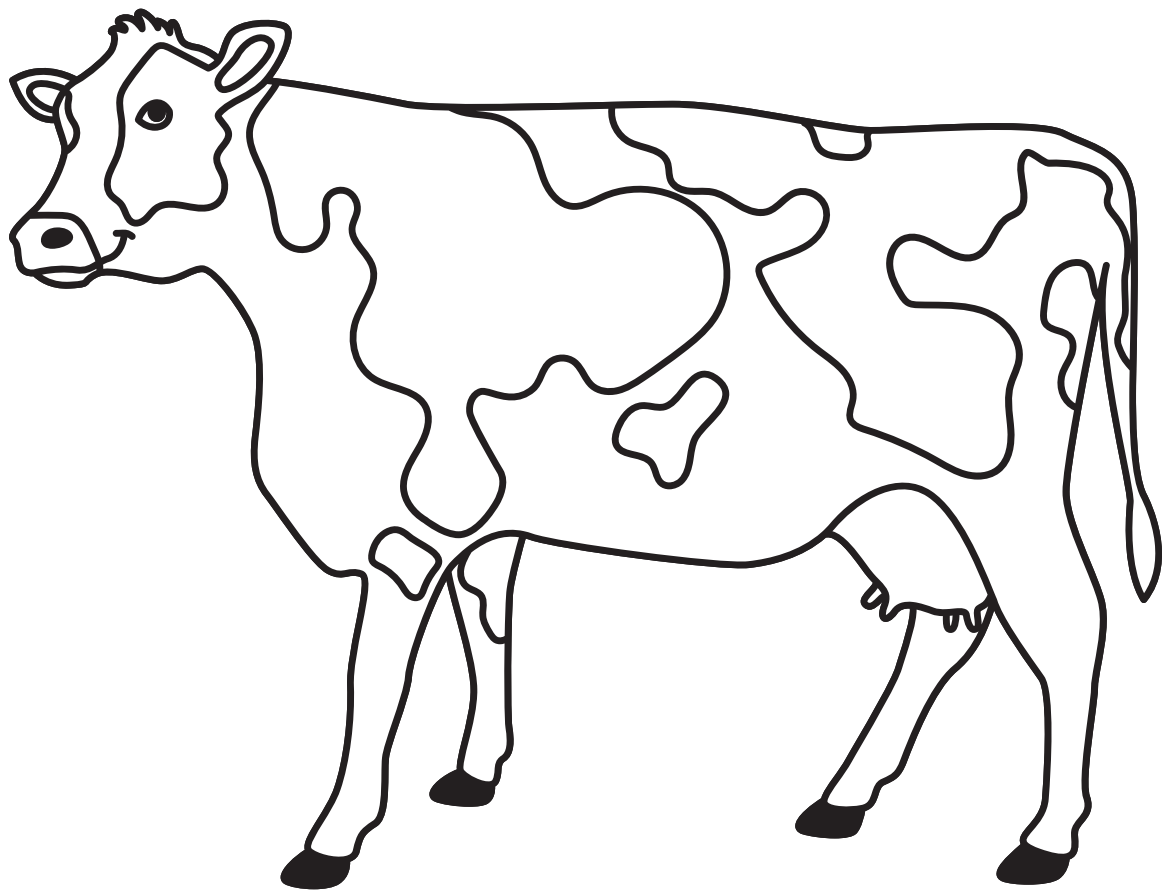

dad

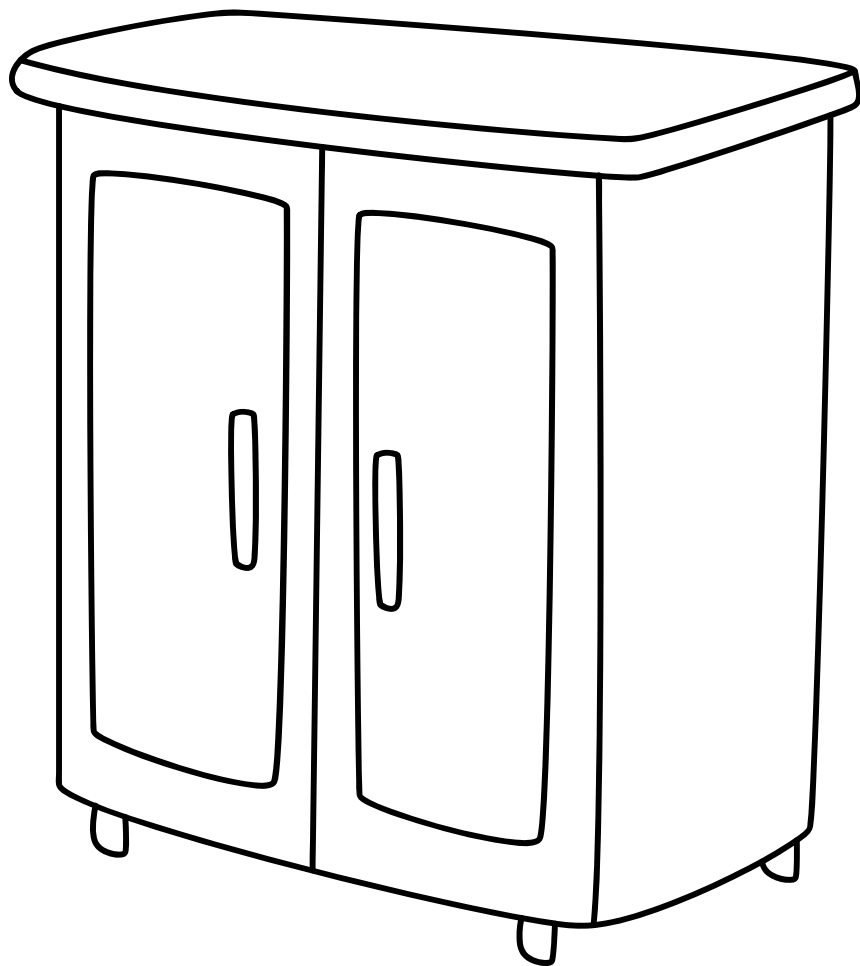



s S

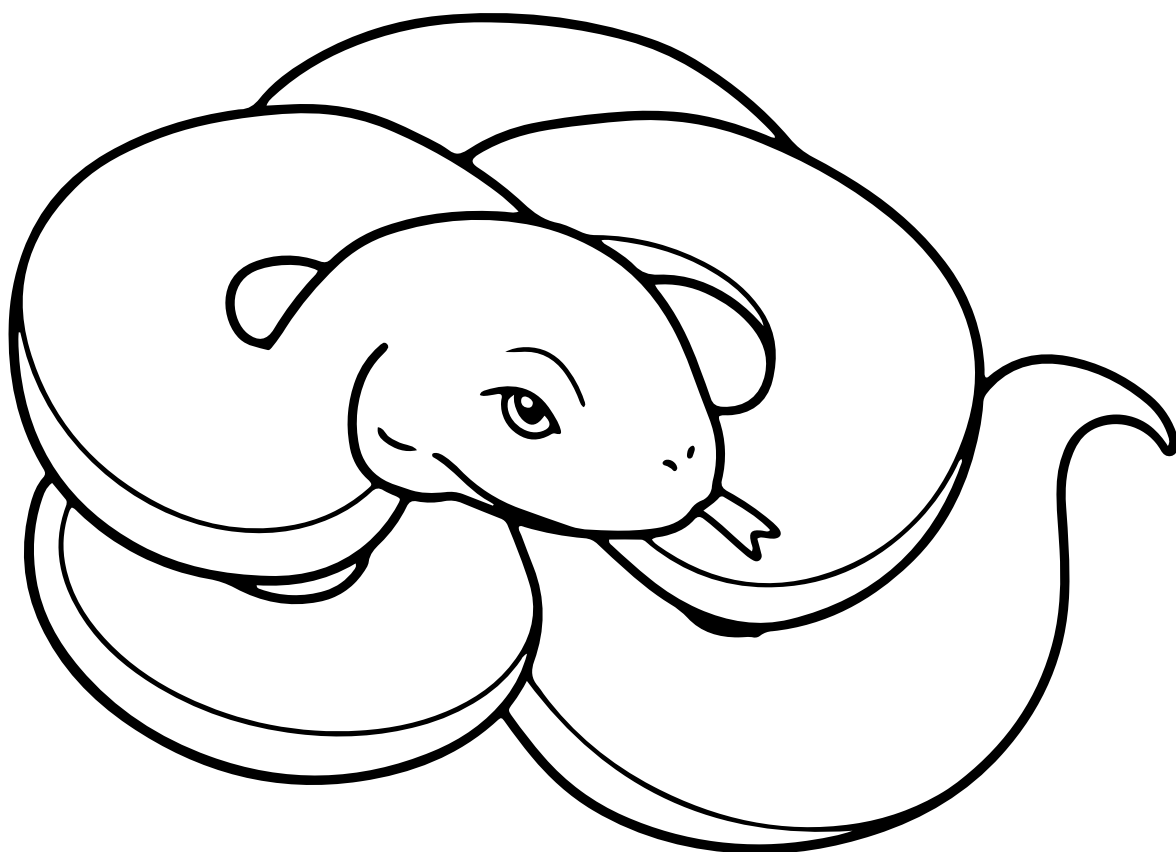

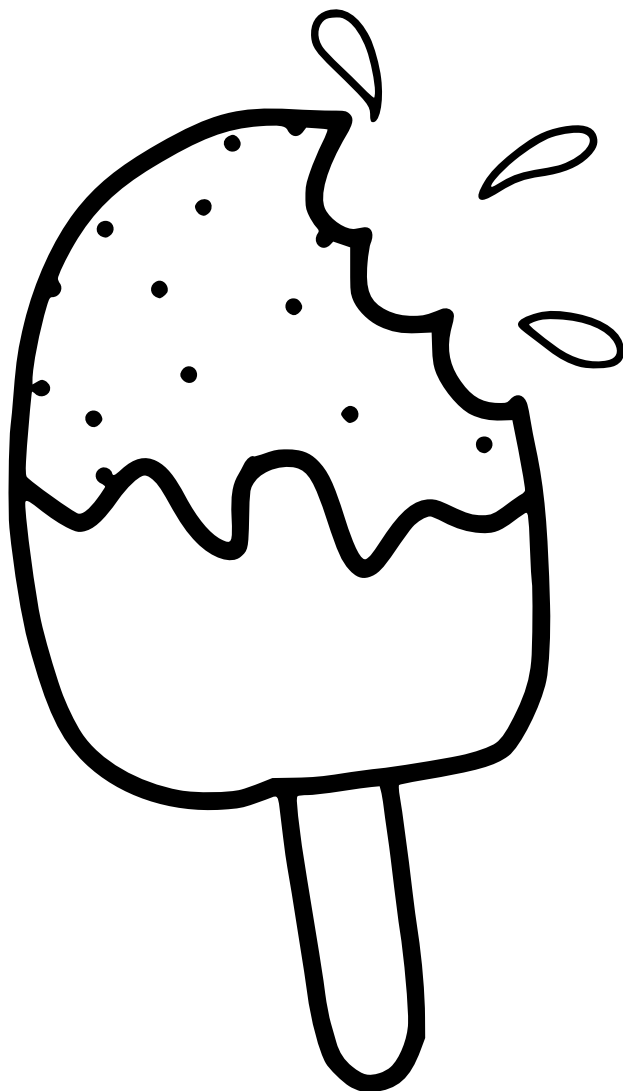
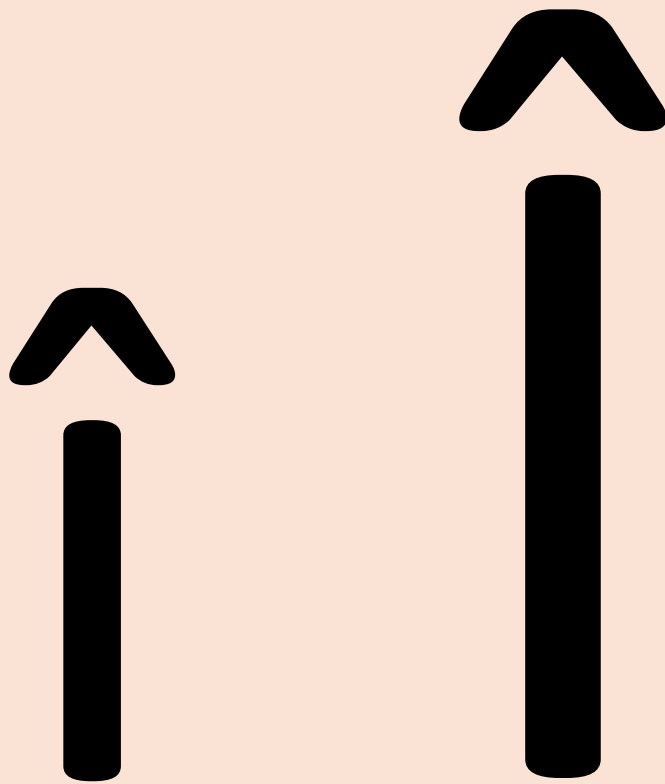

â

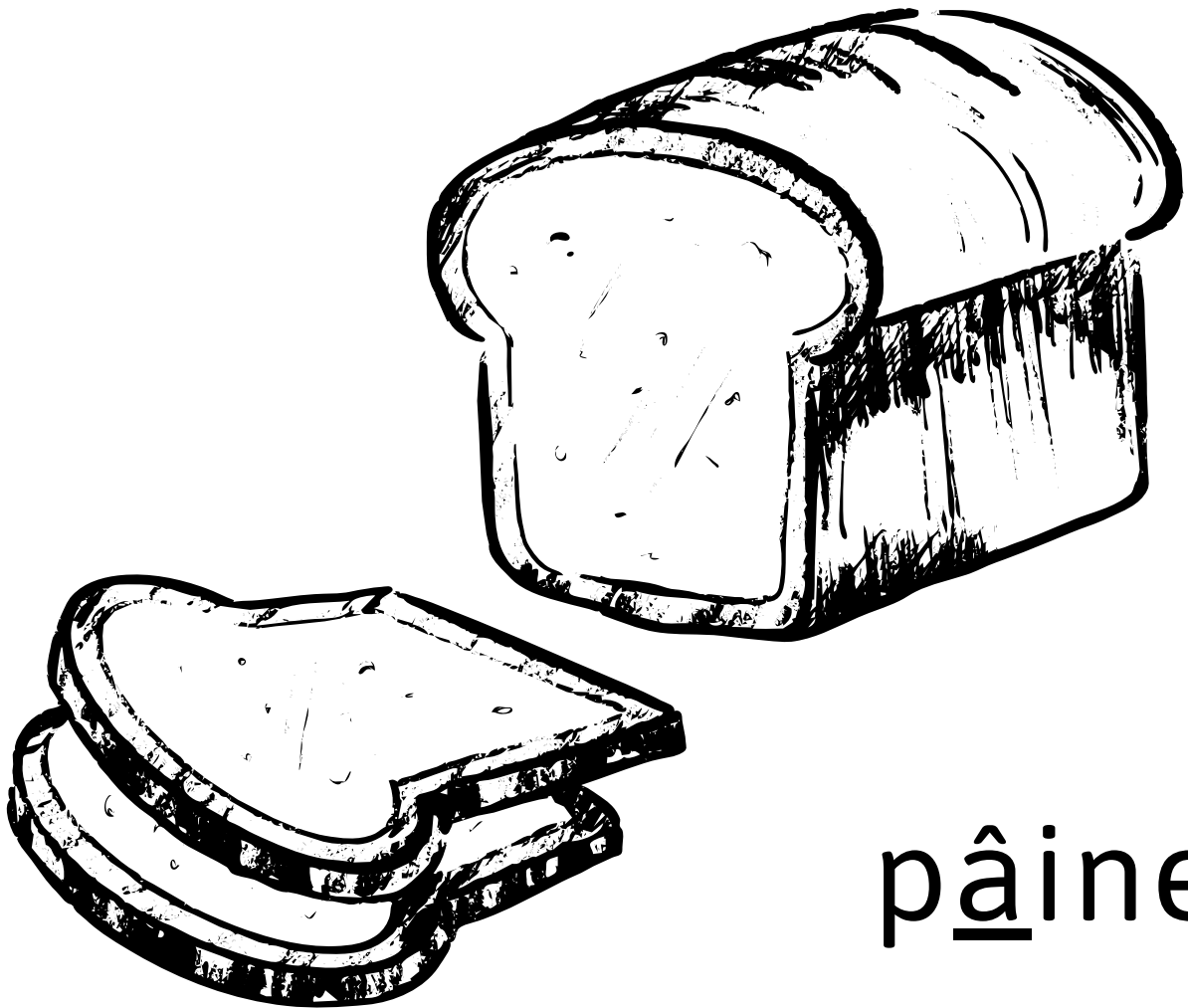

pâine

b B

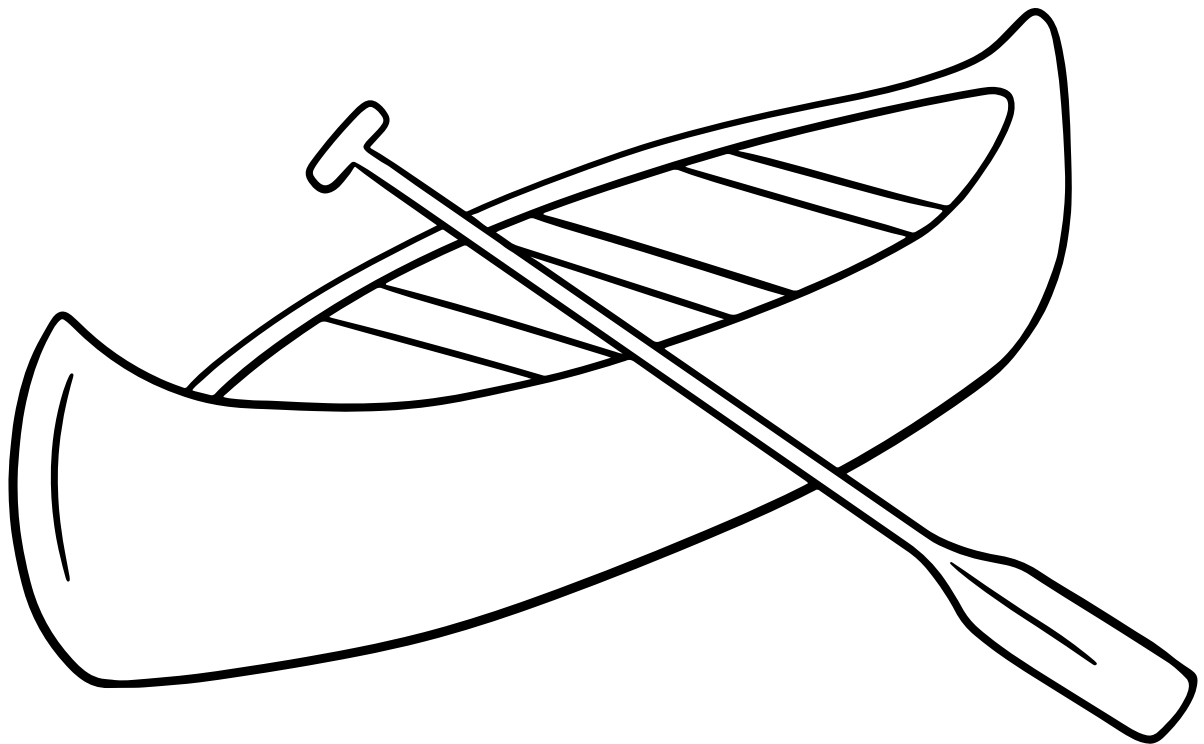

ز z

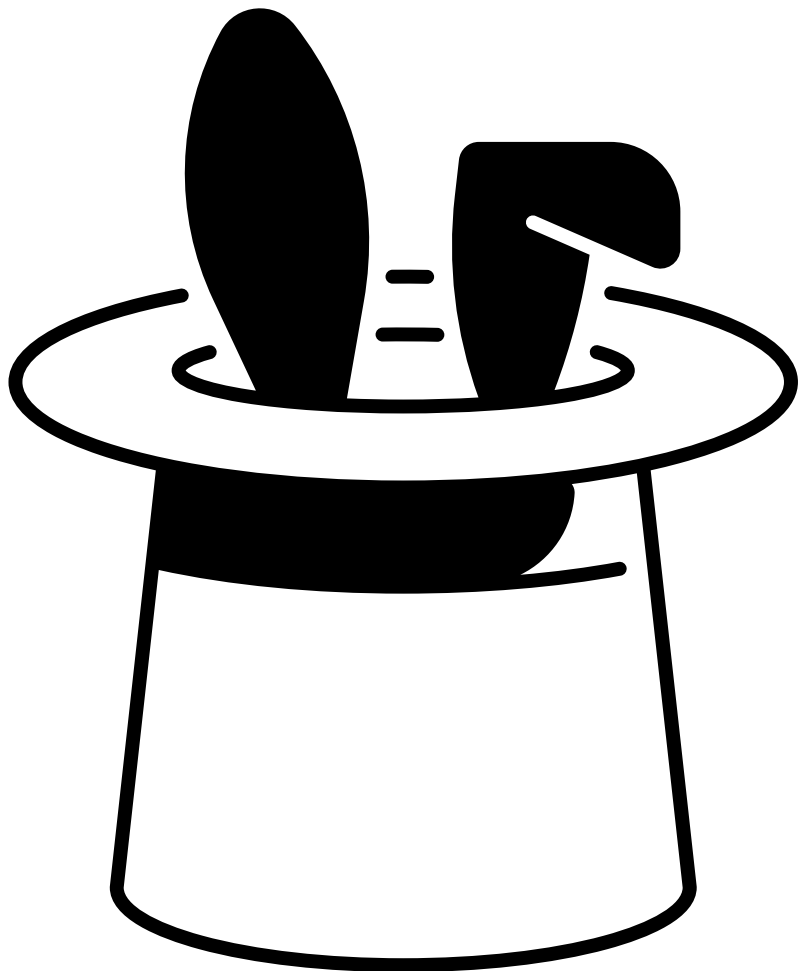

h H

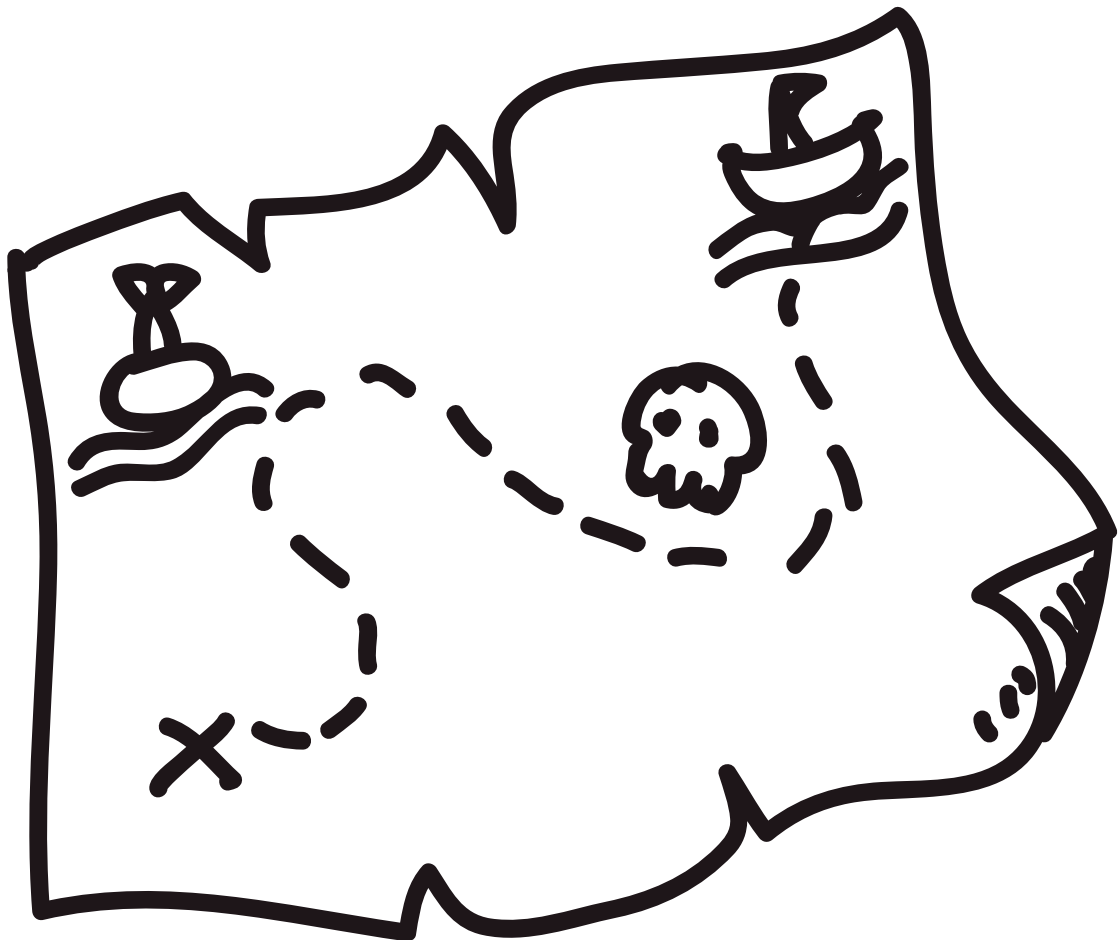

gg G

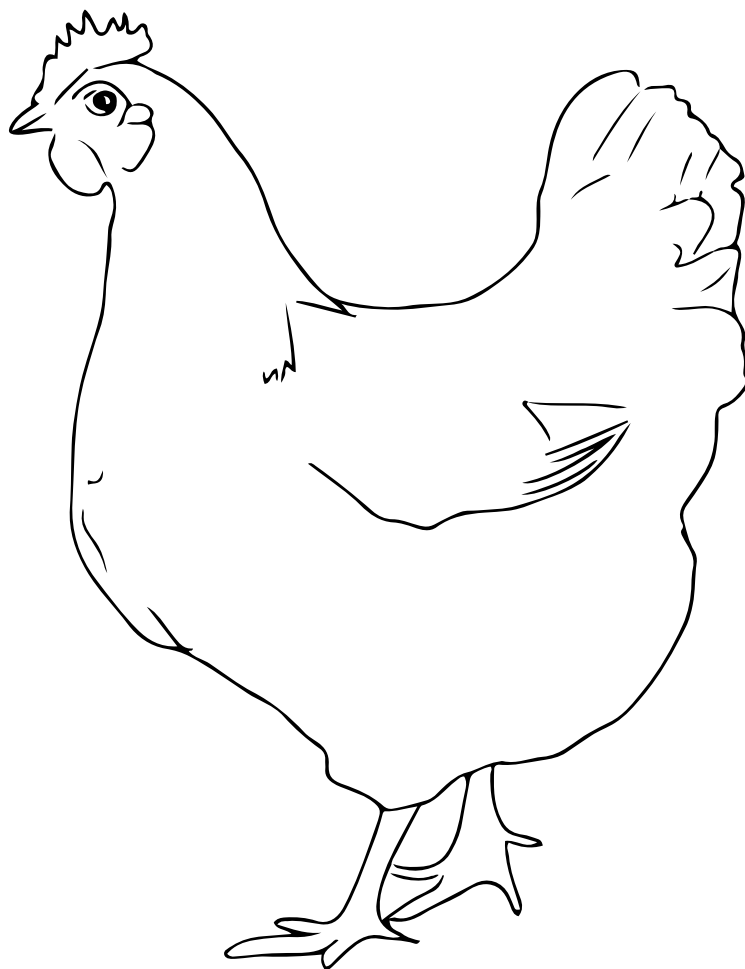

𠂆 𠂇

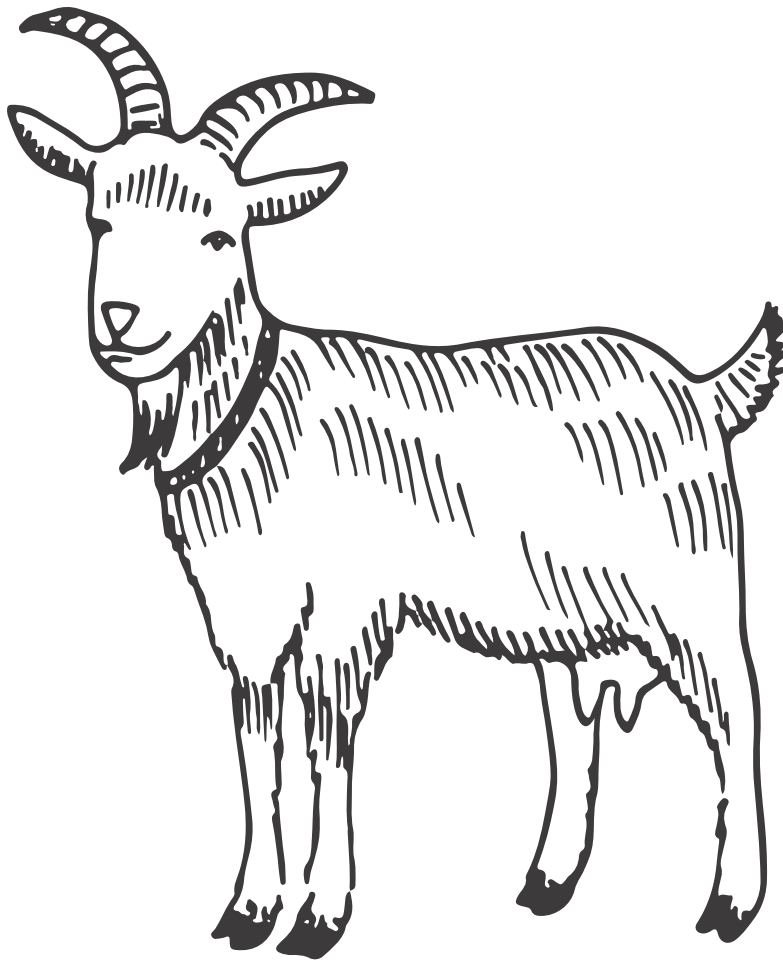



z Z

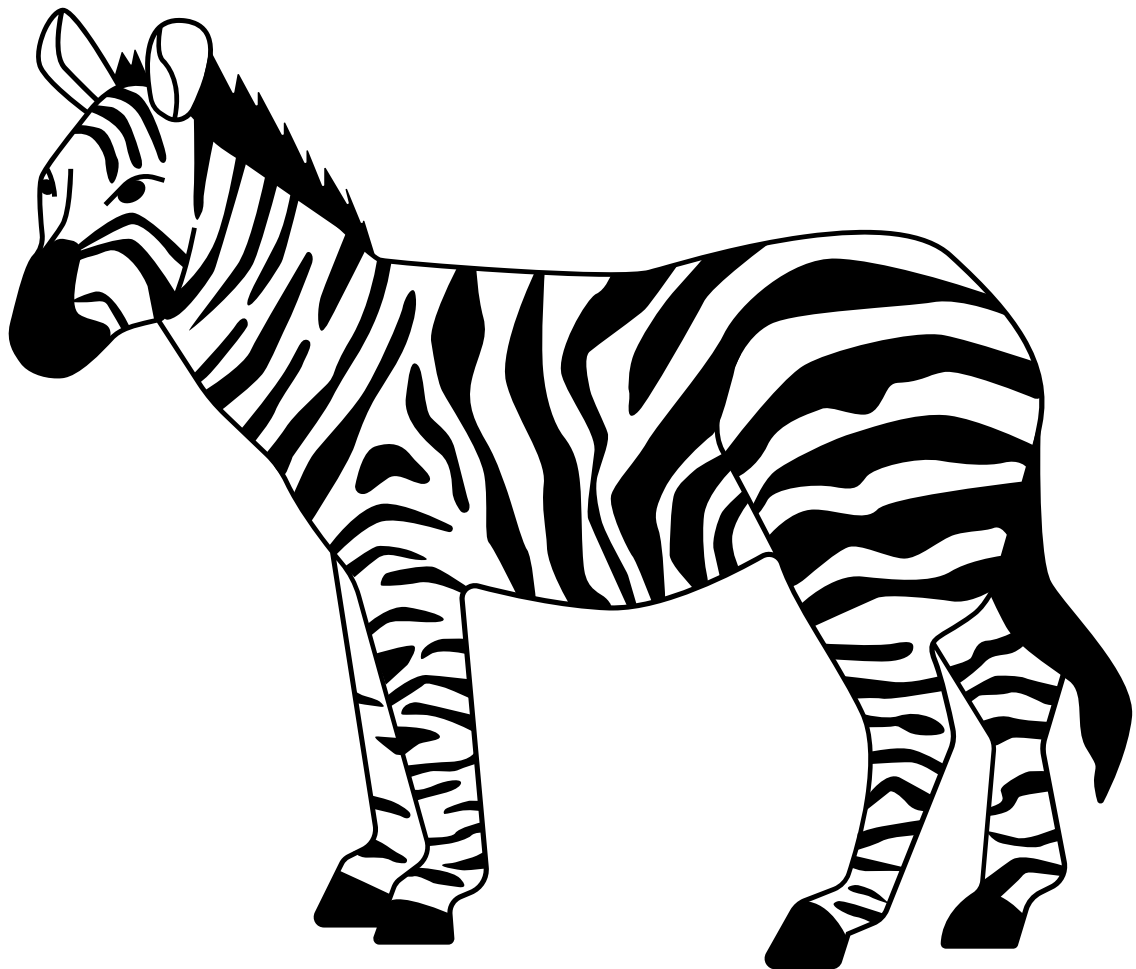

f F

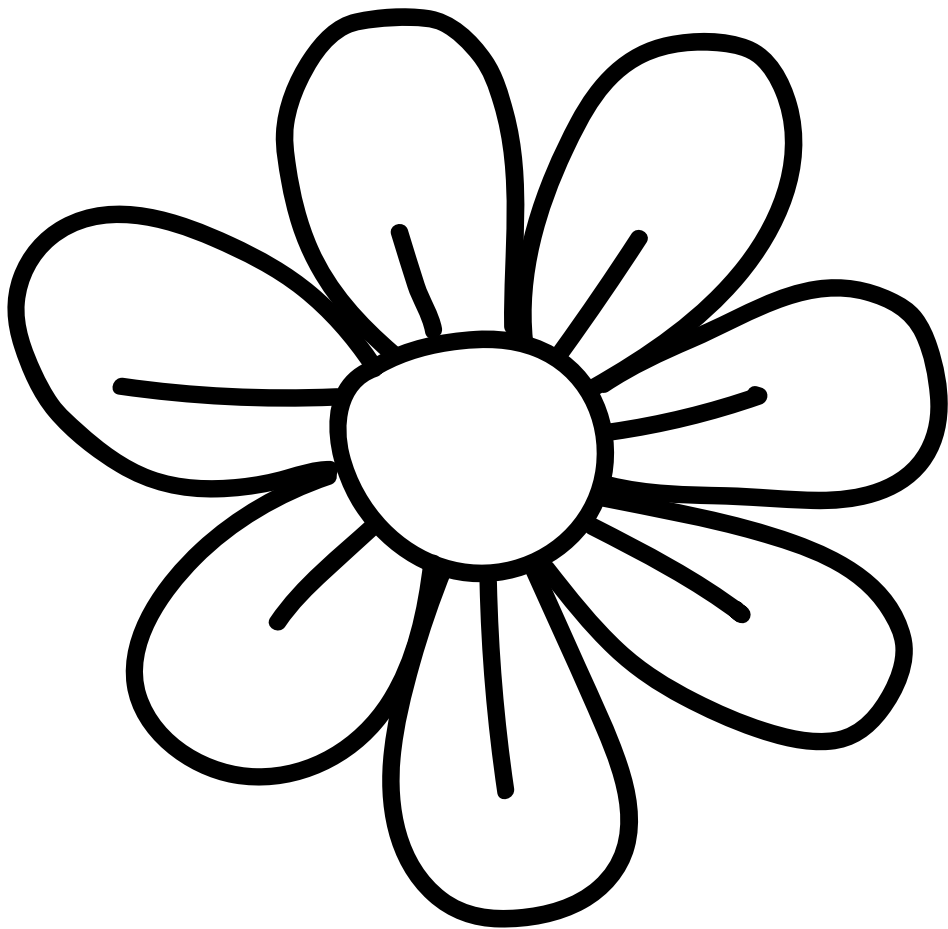

x X

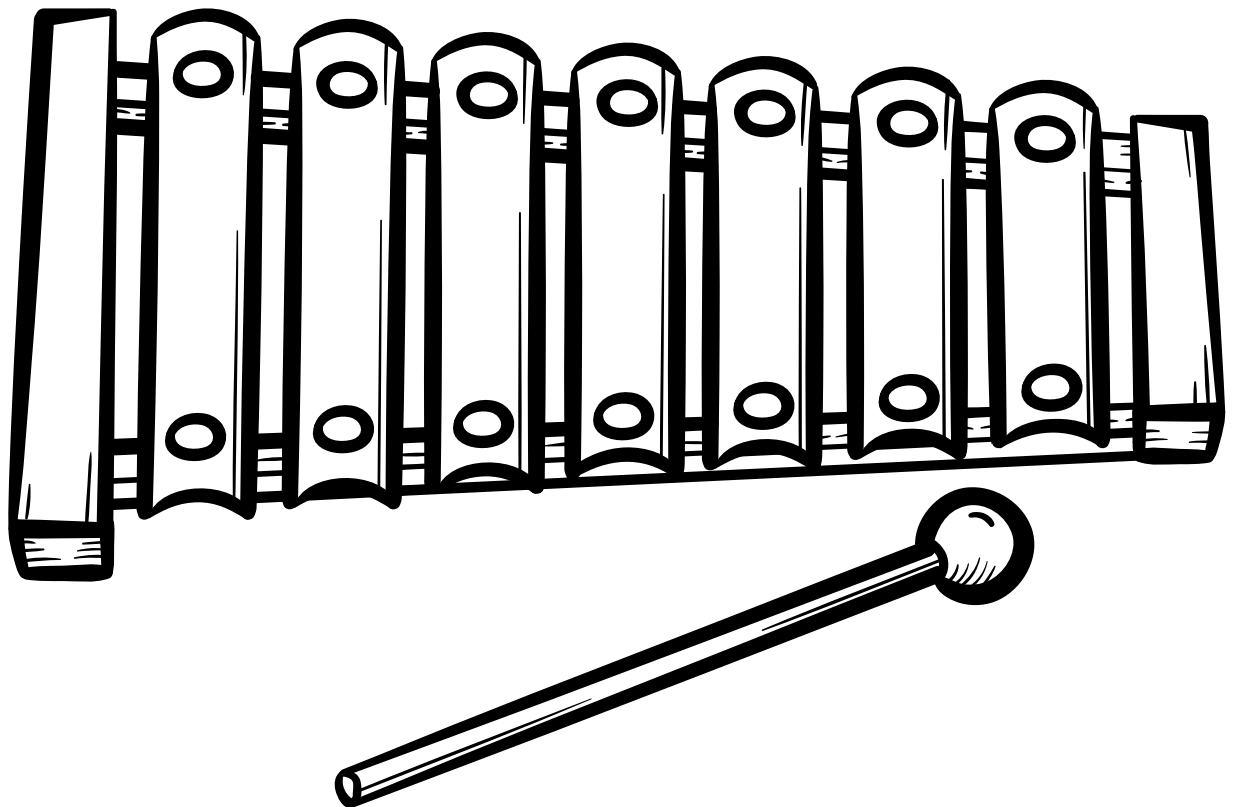

k k



w W

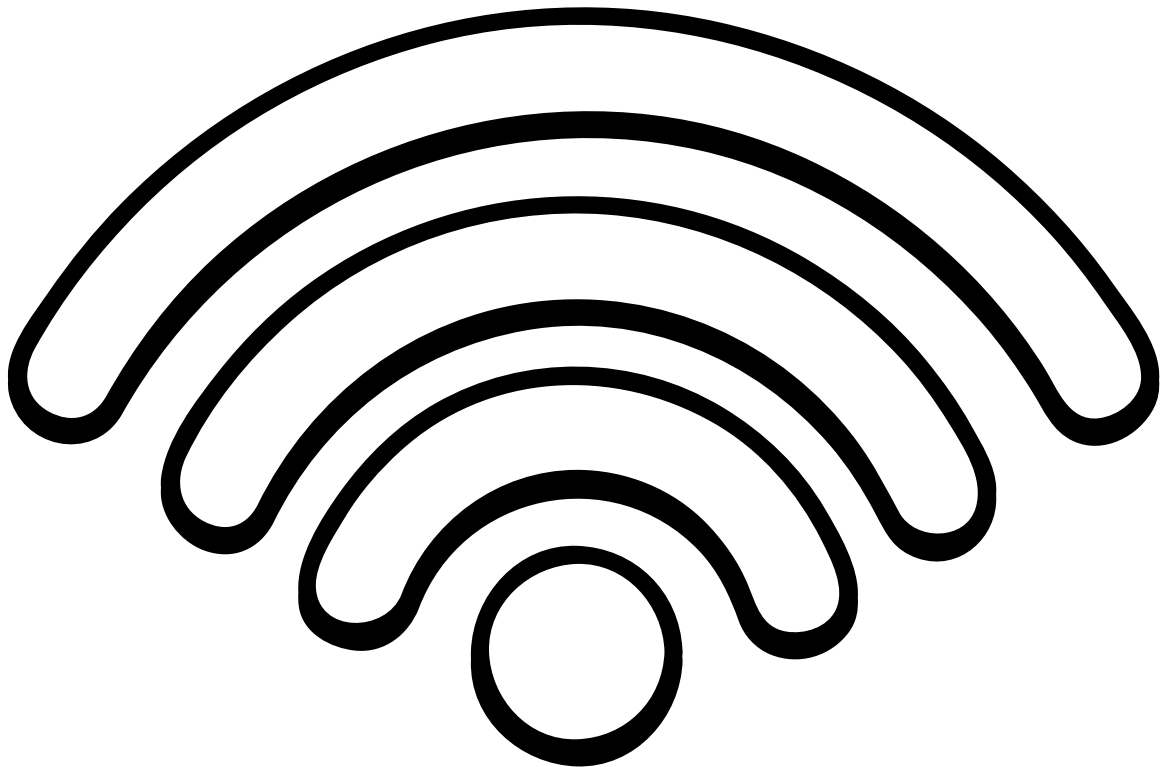

y Y

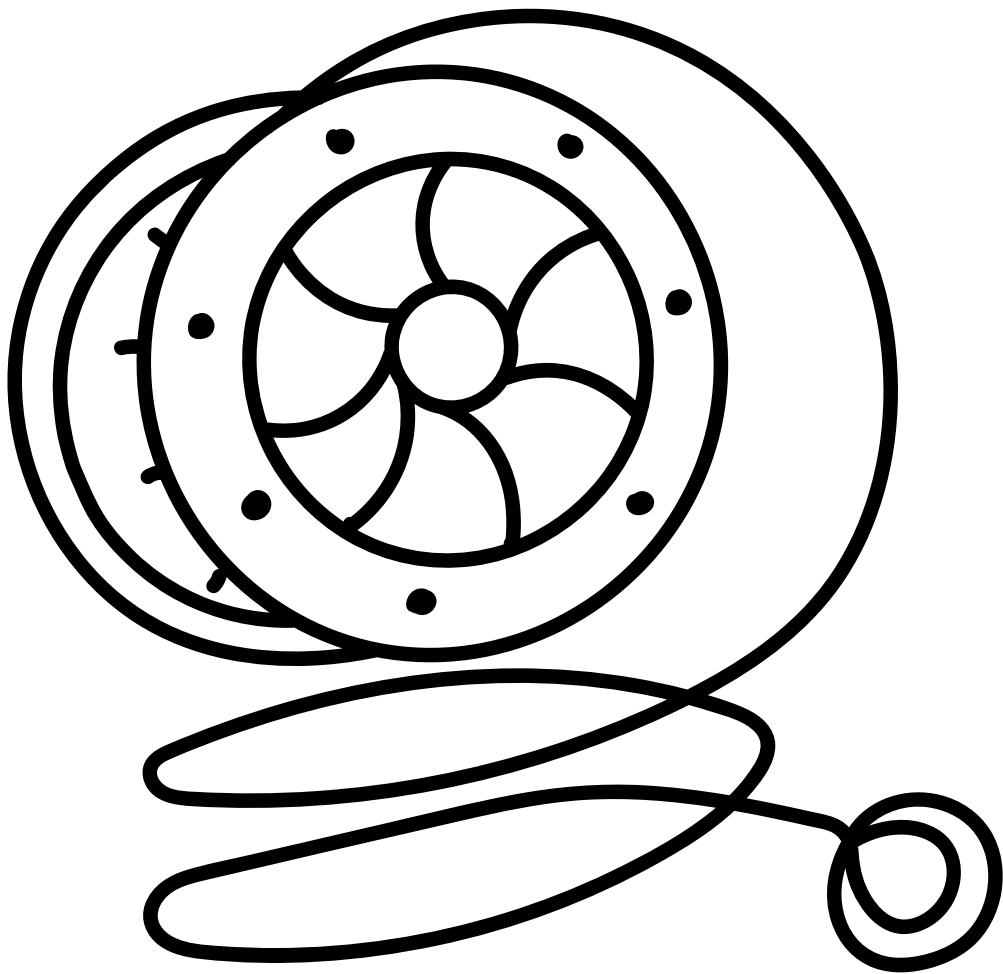

q Q

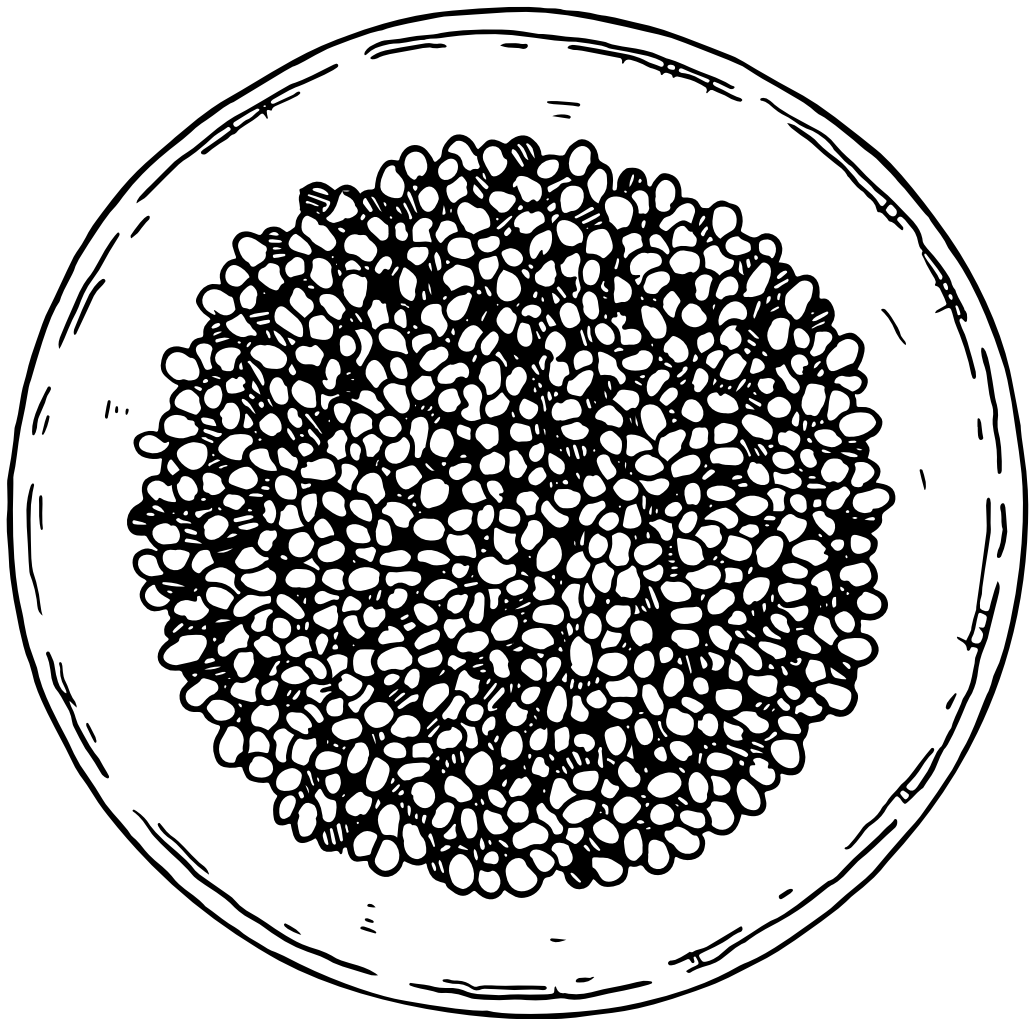

q Q

